



# Living Top 15/30 kg

Slides for suspended panels  
Sistemi di scorrimento per ante sospese



# Living Top 15/30 kg

Adjustable sliding system for suspended panels with damped and standard stops.

Sistema di scorrevoli regolabili per ante sospese con fermi ammortizzati e standard.



## The ideal solution that grants the highest aesthetic results

Living Top is an adjustable system with upper sliding, designed for wooden doors weighing up to 30 kg and with soft-closing option.

**The system represents the best solution to realize applications with clean and linear aesthetic, thanks to flat-bottom with no lower profiles needed.**

Living Top is extremely easy to install, thanks to sliding trolleys automatic fastening system.

Living Top is the ideal solution from Terno Scorrevoli dedicated to living spaces, offices and contract.

## La soluzione ideale che garantisce un alto livello estetico

Living Top è un sistema regolabile a scorrimento superiore per ante in legno fino a 30 kg con fermi ammortizzati.

**Il sistema rappresenta la soluzione ottimale per ottenere un'estetica pulita e lineare, grazie all'assenza di profili inferiori.**

Living Top è estremamente semplice da installare, grazie ai sistemi automatici di aggancio degli scorrevoli.

Living Top è la soluzione ideale di Terno Scorrevoli per la zona giorno, l'ufficio o il settore contract.



**Living Top 15/30 kg** COMPLETE BOX KIT / KIT COMPLETO IN SCATOLA 

<b>K</b>	Complete kit / Kit completo		
	.		
	1251		
	1252		
		.	
			<b>1</b> N.2 Standard stoppers N.2 Fermi standard
			<b>2</b> N.2 Soft damper stoppers N.2 Fermi ammortizzati
			<b>3</b> N.1 Soft damper stopper + N.1 Standard stopper N.1 Fermo ammortizzato + N.1 Fermo standard

EXAMPLE / ESEMPIO

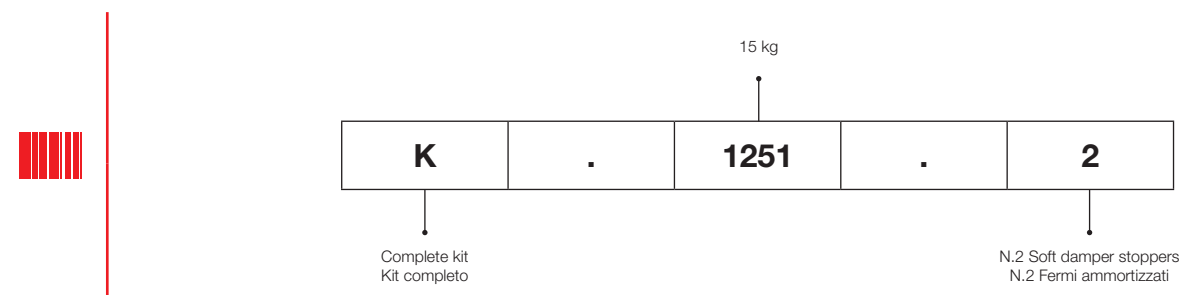

Tracks / Binari		ALUMINUM FINISHES CODES / CODICI FINITURE ALLUMINIO	
CODE / CODICE			FINISH COLOR / COLORE FINITURA
8 00 0.0 .....		00 G	Raw / Mill Finish / Neutro / Grezzo
8 01 0.0 .....		01 A	Anodized Silver / Argento
8 14 0.0 .....		14 N	Anodized Black / Nero
			STANDARD

# Living Top 15 kg



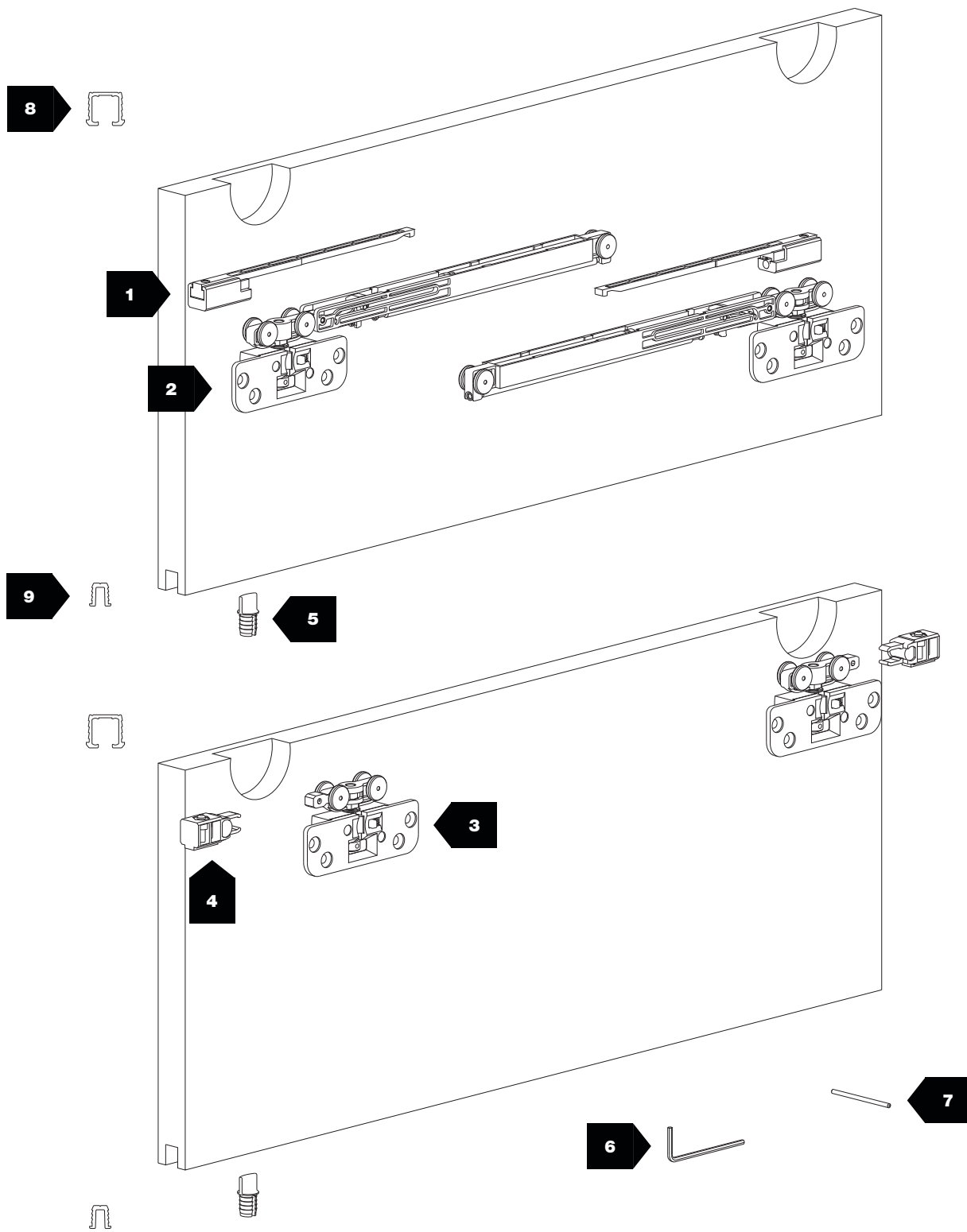



Slides for suspended panels  
Sistemi di scorrimento per ante sospese



Min. 400 mm

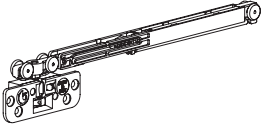

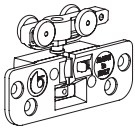
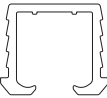
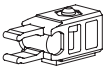
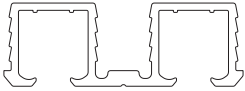
15 kg

N°	Barcode	Image	kg		N°	Barcode	Image	kg	
1	2166/03		15		6	409		15	
2	2174		15		7	973		15	
3	2173		15		8	2175 8 00 0.02175 8 01 0.02175		15	
4	2162		15		8	2172 8 00 0.02172 8 01 0.02172		15	OPTIONAL +
5	2168		15		9	2170 8 00 0.02170 8 01 0.02170		15	

# Living Top 15 kg

Slides for suspended panels  
Sistemi di scorrimento per ante sospese



Kit for N.1 door  
Kit per N.1 anta



N.2 Soft damper stoppers  
N.2 Fermi ammortizzati

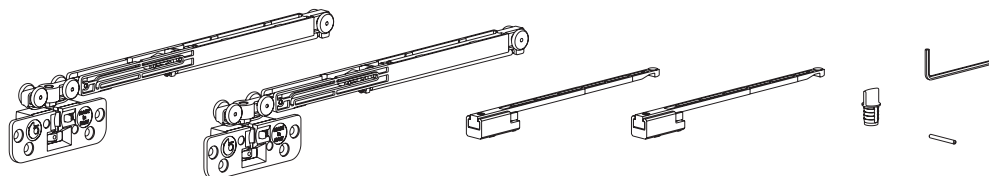

OLD CODE	NEW CODE	Weight	Quantity
2174/A/2	K.1251.2	15 kg	10x



Kit for N.1 door  
Kit per N.1 anta



N.1 Soft damper stoppers  
N.1 Fermi ammortizzati



N.1 Standard stoppers  
N.1 Fermi standard

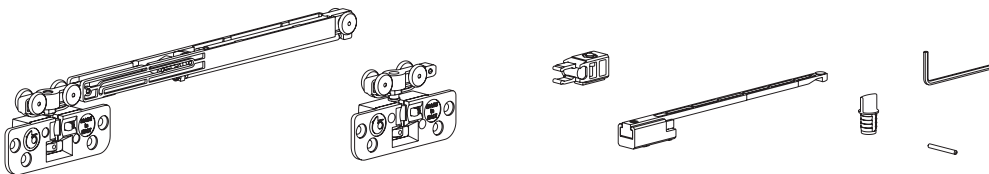

OLD CODE	NEW CODE	Weight	Quantity
2174/A/1	K.1251.3	15 kg	10x



Kit for N.1 door  
Kit per N.1 anta



N.2 Standard stoppers  
N.2 Fermi standard

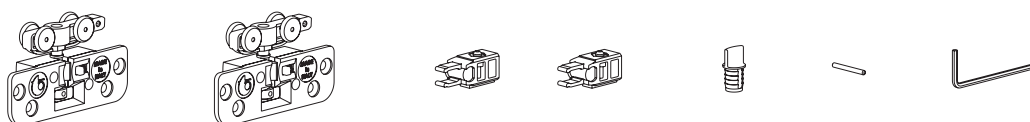

OLD CODE	NEW CODE	Weight	Quantity
2173/A	K.1251.1	15 kg	10x

## MEASUREMENTS DESCRIPTION / DESCRIZIONE MISURE

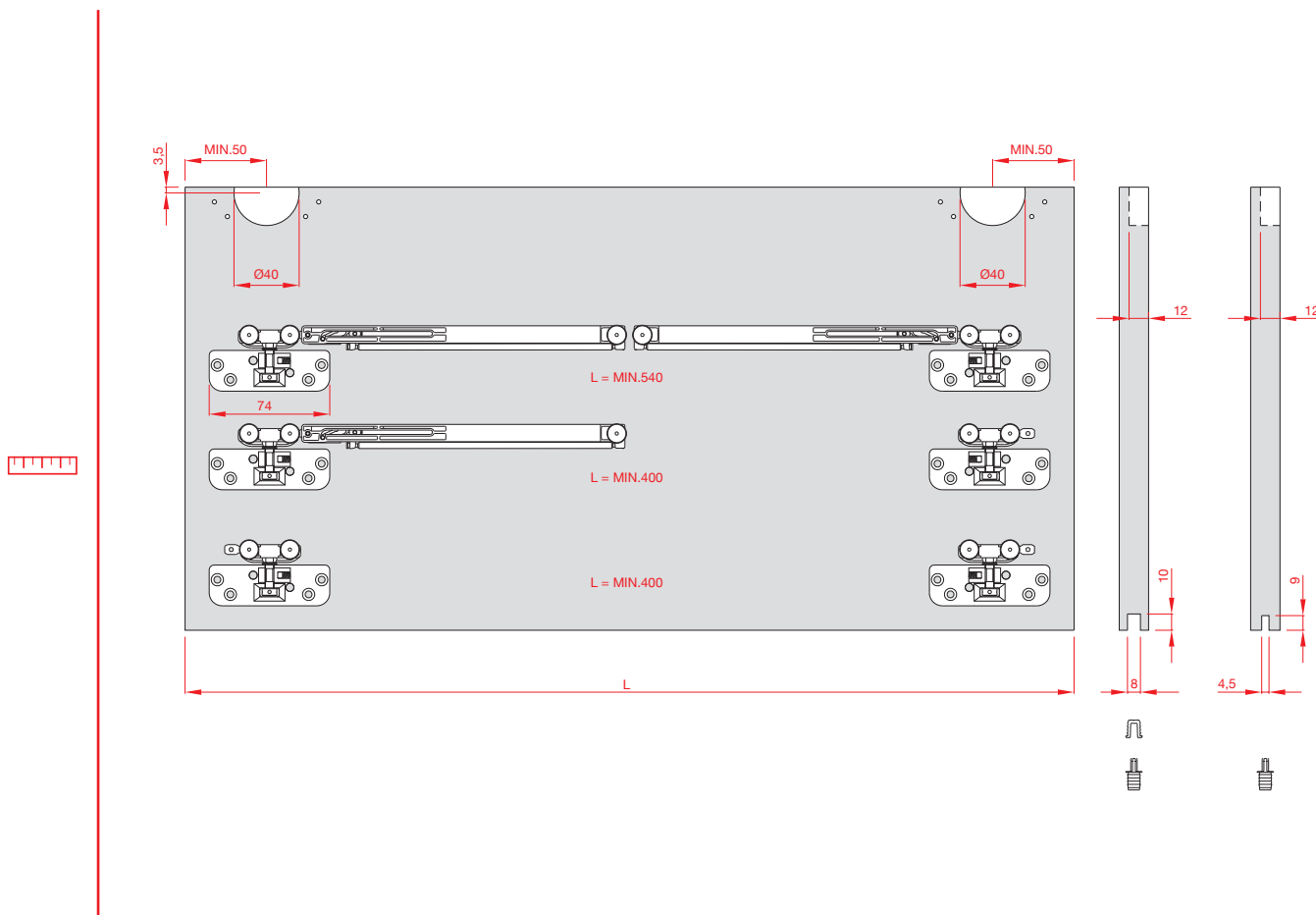



MEASUREMENTS DESCRIPTION / DESCRIZIONE MISURE

SP.18 → Z=9 X=24 W=4 Y=7  
 SP.20 → Z=10 X=26 W=6 Y=9  
 SP.22 → Z=11 X=28 W=8 Y=11

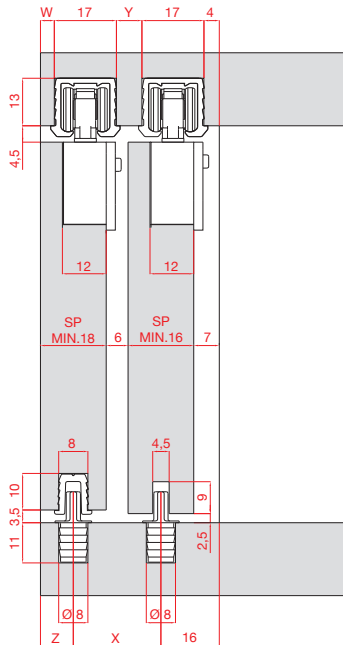

N.2 DOORS WITH SINGLE TRACK ART. 2175 / N.2 ANTE CON BINARIO SINGOLO ART. 2175

SP.16 → X=8 Y=10 Z=7  
 SP.18 → X=6 Y=9 Z=6  
 SP.20 → X=4 Y=8 Z=5  
 SP.22 → X=2 Y=7 Z=4

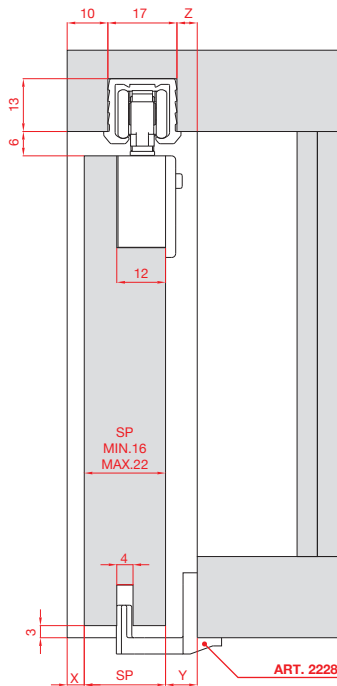

SP.16 → X=8 W=11 Y=9 Z=6  
 SP.18 → X=6 W=9 Y=8 Z=5  
 SP.20 → X=4 W=7 Y=7 Z=4  
 SP.22 → X=2 W=5 Y=6 Z=3

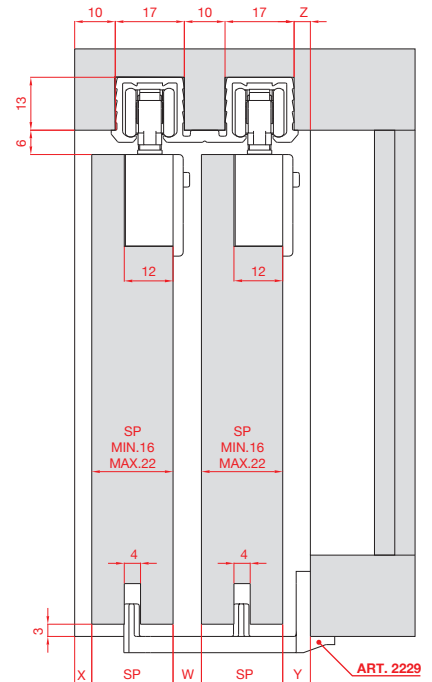

OPTIONAL

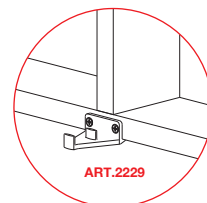
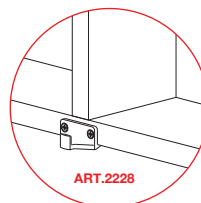
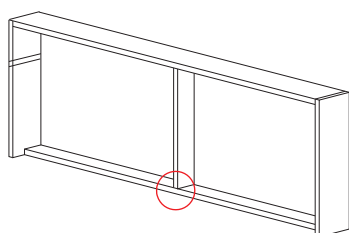

N.2 DOORS WITH DOUBLE TRACK ART. 2172 / N.2 ANTE CON BINARIO DOPPIO ART. 2172

# Living Top 30 kg



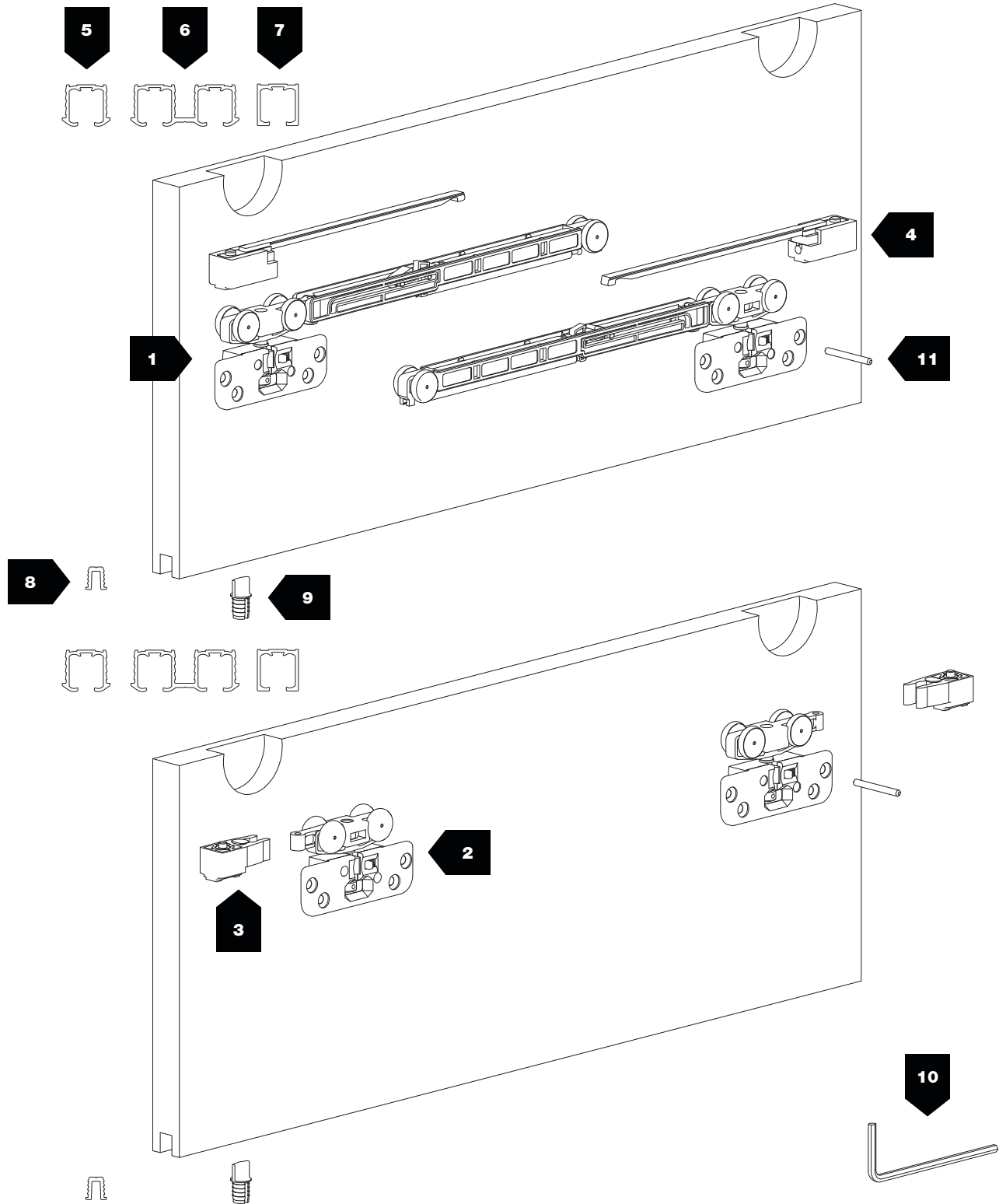



Slides for suspended panels  
Sistemi di scorrimento per ante sospese

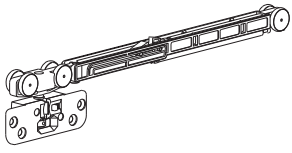
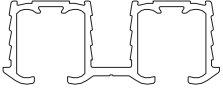
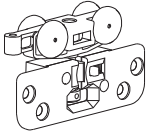
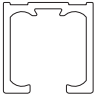
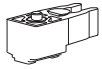

Min. 400 mm



Max 30 Kg

N°	Barcode		kg		N°	Barcode		kg	
1	2654		30		6	2652 8 00 0.02652 8 01 0.02652		30	
2	2656		30		7	2651 8 00 0.02651 8 01 0.02651		30	
3	2657		30		8	2170 8 00 0.02170 8 01 0.02170		30	
4	2655		30		9	2168		30	
5	2650 8 00 0.02650 8 01 0.02650		30		10	437		30	
					11	973		30	



# Living Top 30 kg

Slides for suspended panels  
Sistemi di scorrimento per ante sospese

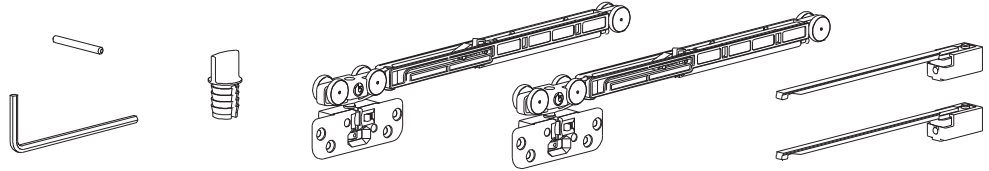
-  Kit for N.1 door  
Kit per N.1 anta
-  N.2 Soft damper stoppers  
N.2 Fermi ammortizzati



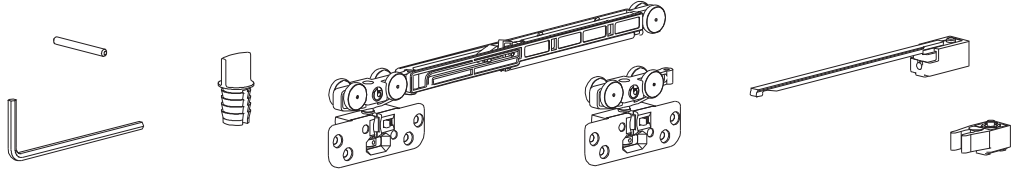

OLD CODE	NEW CODE		
2654/A/2	K.1252.2	<b>30 kg</b>	10x

-  Kit for N.1 door  
Kit per N.1 anta
-  N.1 Soft damper stoppers  
N.1 Fermi ammortizzati
-  N.1 Standard stoppers  
N.1 Fermi standard



OLD CODE	NEW CODE		
2654/A/1	K.1252.3	<b>30 kg</b>	10x

-  Kit for N.1 door  
Kit per N.1 anta
-  N.2 Standard stoppers  
N.2 Fermi standard

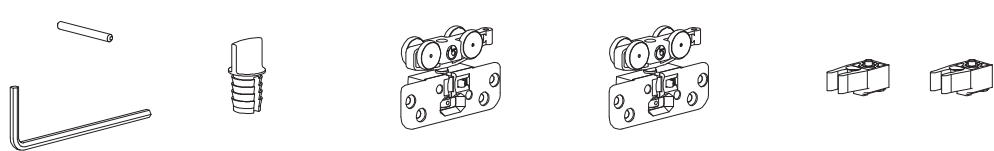

OLD CODE	NEW CODE		
2656/A	K.1252.1	<b>30 kg</b>	10x

## MEASUREMENTS DESCRIPTION / DESCRIZIONE MISURE

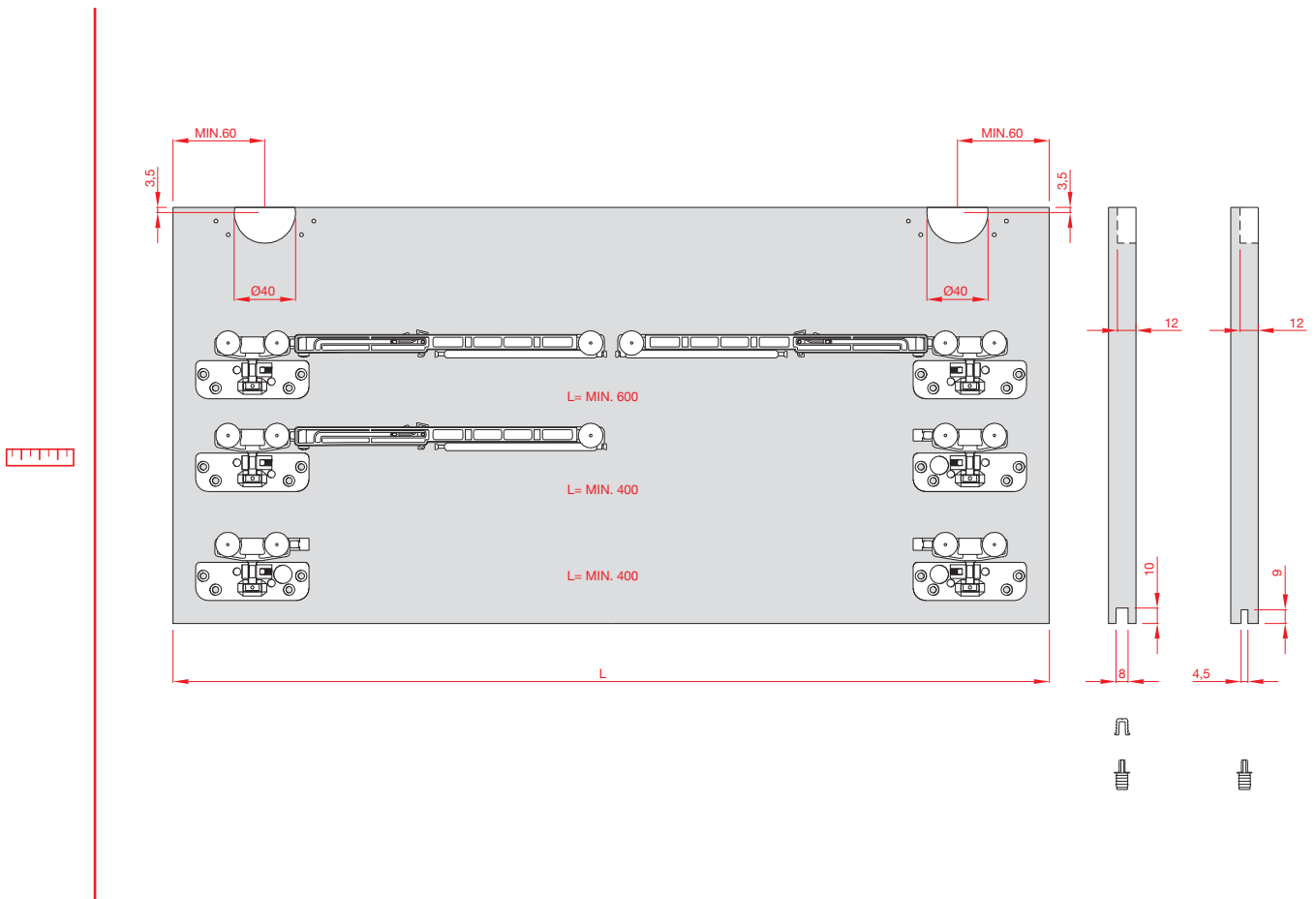

MEASUREMENTS DESCRIPTION / DESCRIZIONE MISURE

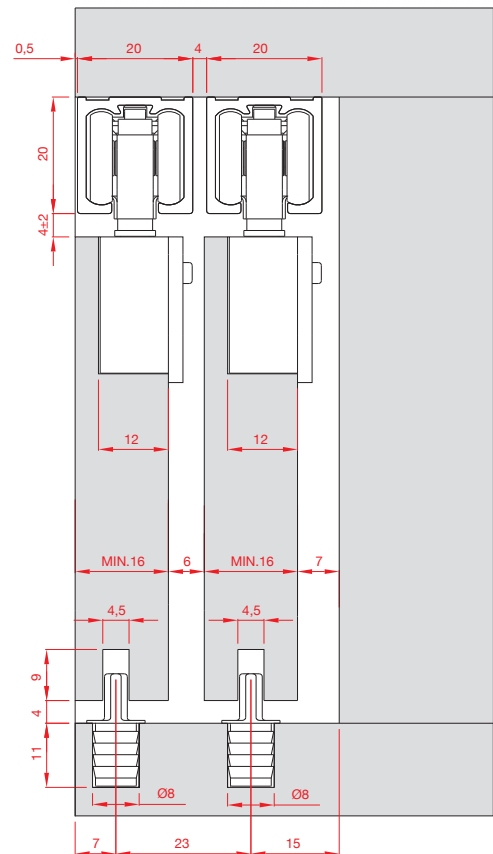
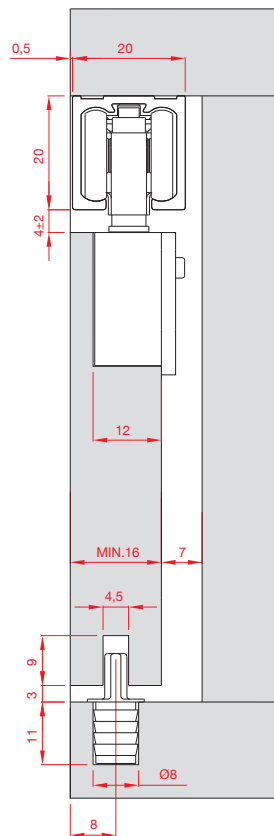
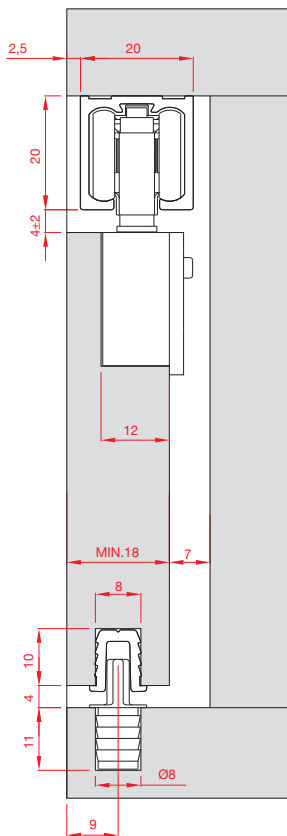
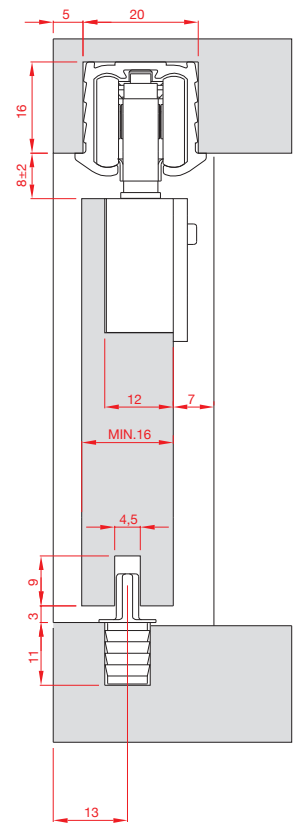
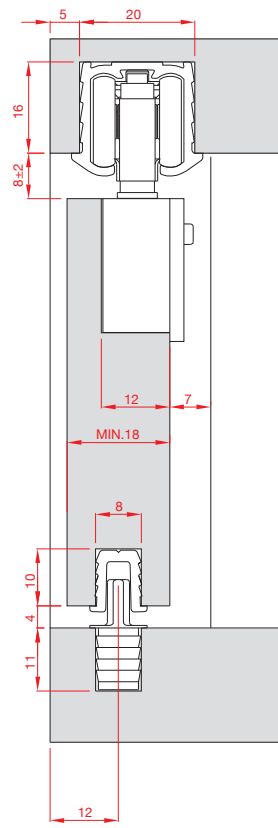
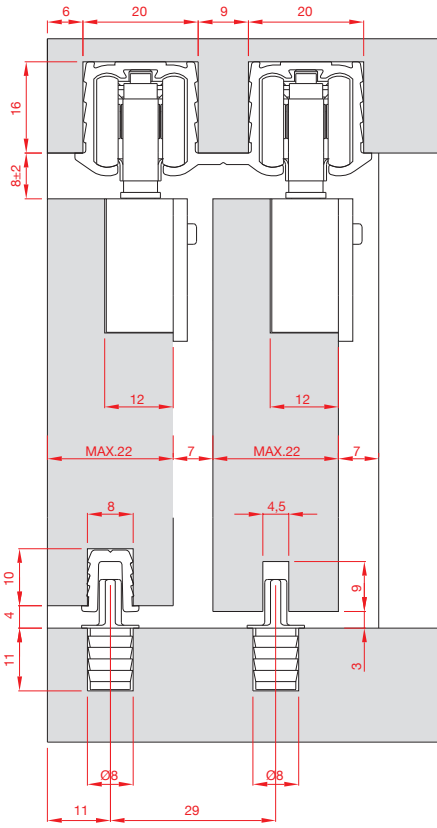



## **Terno Scorrevoli S.p.A.**

**Via Ravenna, 4 - 20814 Varedo (MB) ITALY  
Phone +39 0362 543001 - Fax +39 0362 582290**

**[terno@ternoscorrevoli.com](mailto:terno@ternoscorrevoli.com)  
[www.ternoscorrevoli.com](http://www.ternoscorrevoli.com)**